

High-side Power Switch ICs [With Diagnostic Function] SI-5151S

Features

- Built-in diagnostic function to detect short and open circuiting of loads and output status signals
- Low saturation PNP transistor use
- Allows direct driving using LS-TTL and C-MOS logic levels
- Built-in overcurrent and thermal protection circuits
- Built-in protection against reverse connection of power supply
- TO220 equivalent full-mold package not require insulation mica

Absolute Maximum Ratings

(Ta = 25°C)

Parameter	Symbol	Ratings	Unit	Conditions
Power supply voltage	V _B	40	V	
Input terminal voltage	V _{IN}	-0.3 to V _B	V	
DIAG terminal voltage	V _{DIAG}	6	V	
Collector-emitter voltage	V _{CE}	40	V	
Output current	I _O	1.8	A	
Power Dissipation	P _{D1}	18	W	With infinite heatsink (T _c = 25°C)
	P _{D2}	1.5	W	Stand-alone without heatsink (T _c = 25°C)
Junction temperature	T _J	-40 to +125	°C	
Operating temperature	T _{OP}	-40 to +100	°C	
Storage temperature	T _{stg}	-40 to +125	°C	

External Dimensions (unit: mm)

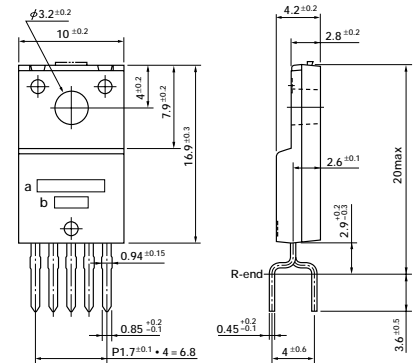

1. GND
 2. V_{IN}
 3. V_O
 4. DIAG
 5. V_B
- a: Part No.
b: Lot No.

(Forming No. 1123)

Electrical Characteristics

(Ta = 25°C unless otherwise specified)

Parameter	Symbol	Ratings			Unit	Conditions
		min	typ	max		
Operating power supply voltage	V _{Bopr}	6.0		30	V	
Quiescent circuit current	I _q		5	12	mA	V _{Bopr} = 14V, V _{IN} = 0V
Saturation voltage of output transistor	V _{CE(sat)}			0.5	V	I _O ≤ 1.0A, V _{Bopr} = 6 to 16V
				1.0	V	I _O ≤ 1.8A, V _{Bopr} = 6 to 16V
Output leak current	I _{O, leak}			2	mA	V _{CEO} = 16V
Input voltage	Output ON	V _{IH}	2.0	V _B	V	V _{Bopr} = 6 to 16V
	Output OFF	V _{IL}	-0.3	0.8	V	V _{Bopr} = 6 to 16V
Input current	Output ON	I _{IH}		1	mA	V _{IN} = 5V
	Output OFF	I _{IL}	-0.1		mA	V _{IN} = 0V
Overcurrent protection starting current	I _S	1.9			A	V _{Bopr} = 14V, V _O = V _{Bopr} - 1.5V
Thermal protection starting temperature	T _{TSD}	125	145		°C	
Open load detection resistor	R _{open}			30	kΩ	V _{Bopr} = 6 to 16V
Output transfer time	T _{ON}		8	30	μs	V _{Bopr} = 14V, I _O = 1A
	T _{OFF}		15	30	μs	V _{Bopr} = 14V, I _O = 1A
DIAG output voltage	V _{DH}	4.5		6	V	V _{CC} = 6V
	V _{DL}			0.3	V	V _{CC} = 6V, I _{DD} = 2mA
DIAG output transfer time	T _{PLH}			30	μs	V _{Bopr} = 14V, I _O = 1A
	T _{PHL}			30	μs	V _{Bopr} = 14V, I _O = 1A
Minimum load inductance	L	1			mH	

Note:

* The rule of protection against reverse connection of power supply is V_B = -13V, one minute (all terminals except, V_B and GND, are open).

Standard Circuit Diagram

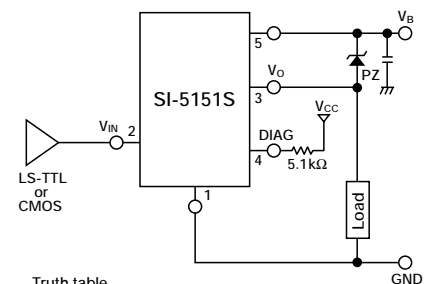

Truth table

V _{IN}	V _O
H	H
L	L

Diagnostic Function

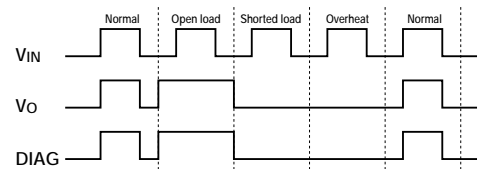

Mode	V _{IN}	V _O	DIAG
Normal	L	L	L
	H	H	H
Open load	L	H	H
	H	H	H
Shorted load	L	L	L
	H	L	L
Overheat	L	L	L
	H	L	L

- DIAG output will be undetermined when a voltage exceeding 25V is applied to V_B terminal.

Electrical Characteristics

■ Quiescent Circuit Current

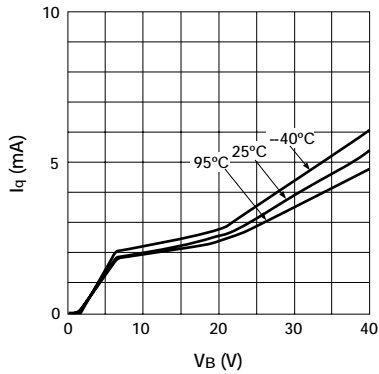

■ Circuit Current

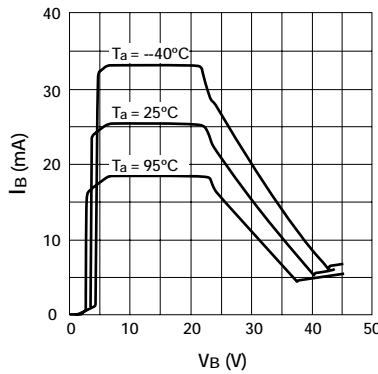

■ Saturation Voltage of Output Transistor

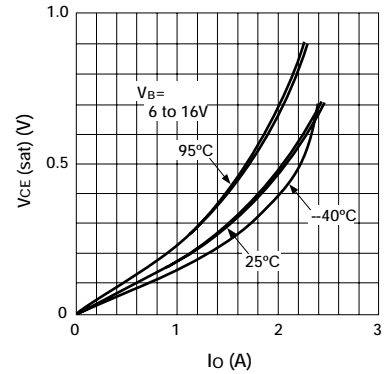

■ Overcurrent Protection Characteristics ($T_a = -40^\circ\text{C}$)

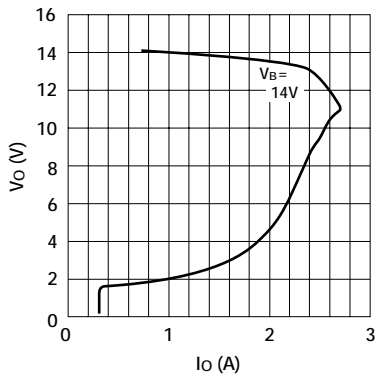

■ Overcurrent Protection Characteristics ($T_a = 25^\circ\text{C}$)

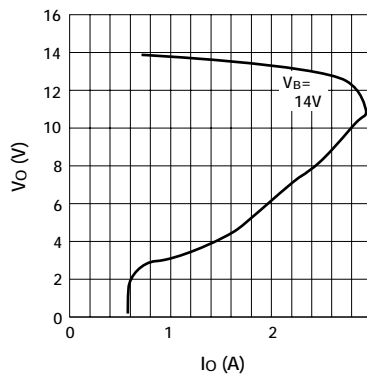

■ Overcurrent Protection Characteristics ($T_a = 100^\circ\text{C}$)

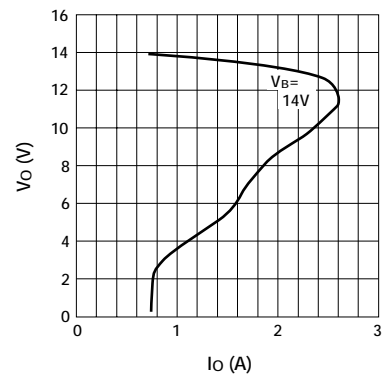

■ Threshold input voltage

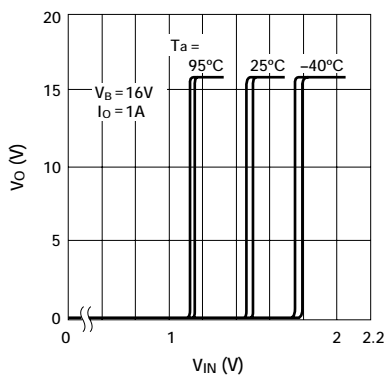

■ Input Current (Output ON)

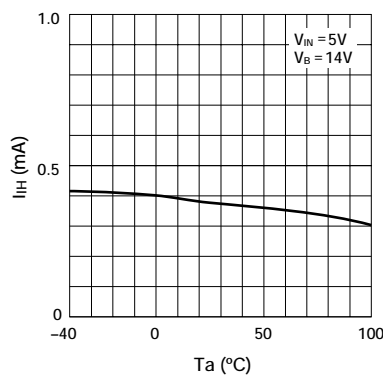

■ Input Current (Output OFF)

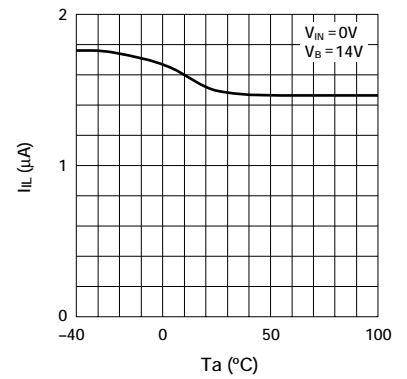

■ Saturation Voltage of DIAG Output

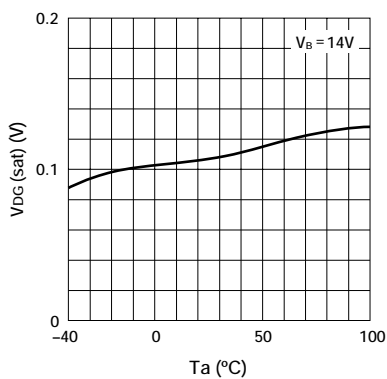

■ Thermal Protection Characteristics

